

1. Stage 1

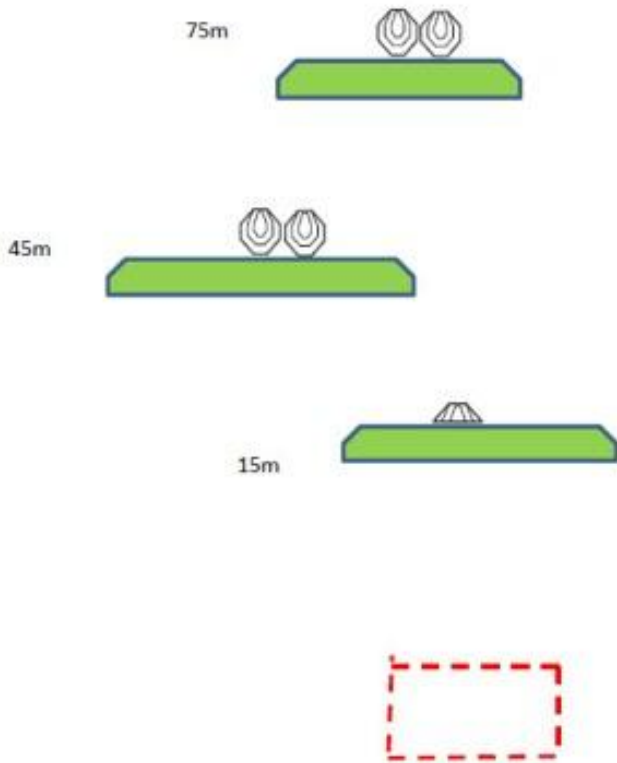

Stage 1

Short Course

Distances: 15-75m

Targets: 5 IPSC mini targets

Minimum Rounds: 10

Maximum Points: 50

Starting Position: Any where in Area A.

Condition: Option 2

Time starts on audio signal

Procedure: On startsignal, engage all targets standing on pallet

IPSC targets will be shoot with minimum two shoots each.

Hotrange with stage 8

CoF	Comstock - Short	Points	50 p
Targets	5 paper, Total 5 targets	Min rounds	10
Firearm	Rifle	Match-%	6.29%

Procedure	On startsignal, engage all targets standing on pallet. IPSC targets will be shoot with minimum two shoots each. Hotrange with stage 8.
Starting position	Option 2
Firearm ready condition	
Start on	Audible signal
Stop on	Last shot
Penalties	As per current edition of rules
Safety angles	L/R
Setup notes	

2. Stage 2

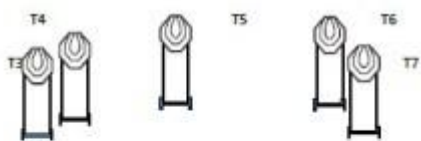

Stage 2
 Medium course
 Distances: 2-90 m
 Targets: 10 IPSC Targets
 Minimum Rounds: 20
 Maximum Points: 100
 Starting Position: Any where in Area A.
 Condition: Option 1
 Time starts on audio signal
 Procedure: On startsignal, engage all targets
 IPSC targets will be shoot with minimum 2
 T1 and T2 are "lean out" targets

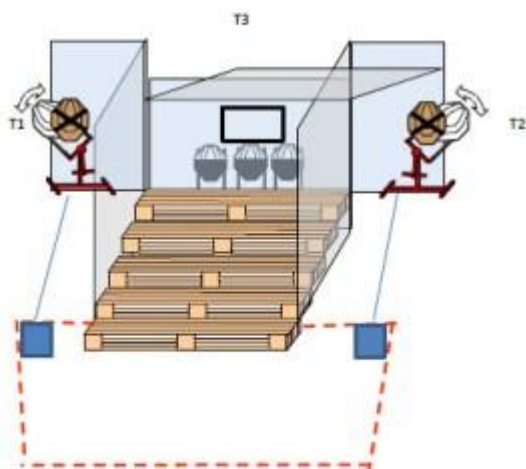

CoF	Comstock - Medium	Points	100 p
Targets	10 paper, 4 no-shoot, Total 10 targets	Min rounds	20
Firearm	Rifle	Match-%	12.58%

Procedure	On startsignal, engage all targets as they appear. IPSC targets will be shoot with minimum two shoots each. T1 and T2 are "lean out" targets.
Starting position	Option 1
Firearm ready condition	
Start on	Audible signal
Stop on	Last shot
Penalties	As per current edition of rules
Safety angles	L/R
Setup notes	

3. Stage 3

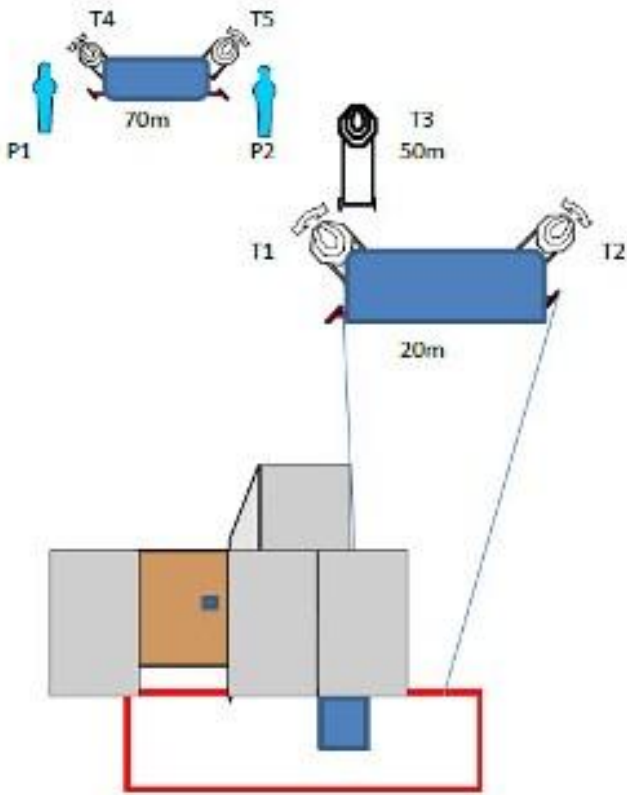

Stage 3

Short course

Distances: 20-70m

Targets: 5 IPSC targets+ 2 IPSC poppers

Minimum rounds 12

Maximum points: 60

Condition: Option 1

Start position: Standing anywhere in Area A

Time starts on audio signal

Procedure: On start signal engage all targets, stompbox releases 2 swingers, P1 release T4 and P2 release T5 IPSC targets will be shoot with minimum two shoots each.

CoF	Comstock - Short	Points	50 p
Targets	4 paper, 2 popper, Total 6 targets	Min rounds	10
Firearm	Rifle	Match-%	6.29%

Procedure	On start signal engage all targets, stompbox releases 2 swingers, P1 release T4 and P2 release T5. IPSC targets will be shoot with minimum two shoots each.
Starting position	Option 1
Firearm ready condition	
Start on	Audible signal
Stop on	Last shot
Penalties	As per current edition of rules
Safety angles	L/R
Setup notes	

4. Stage 4

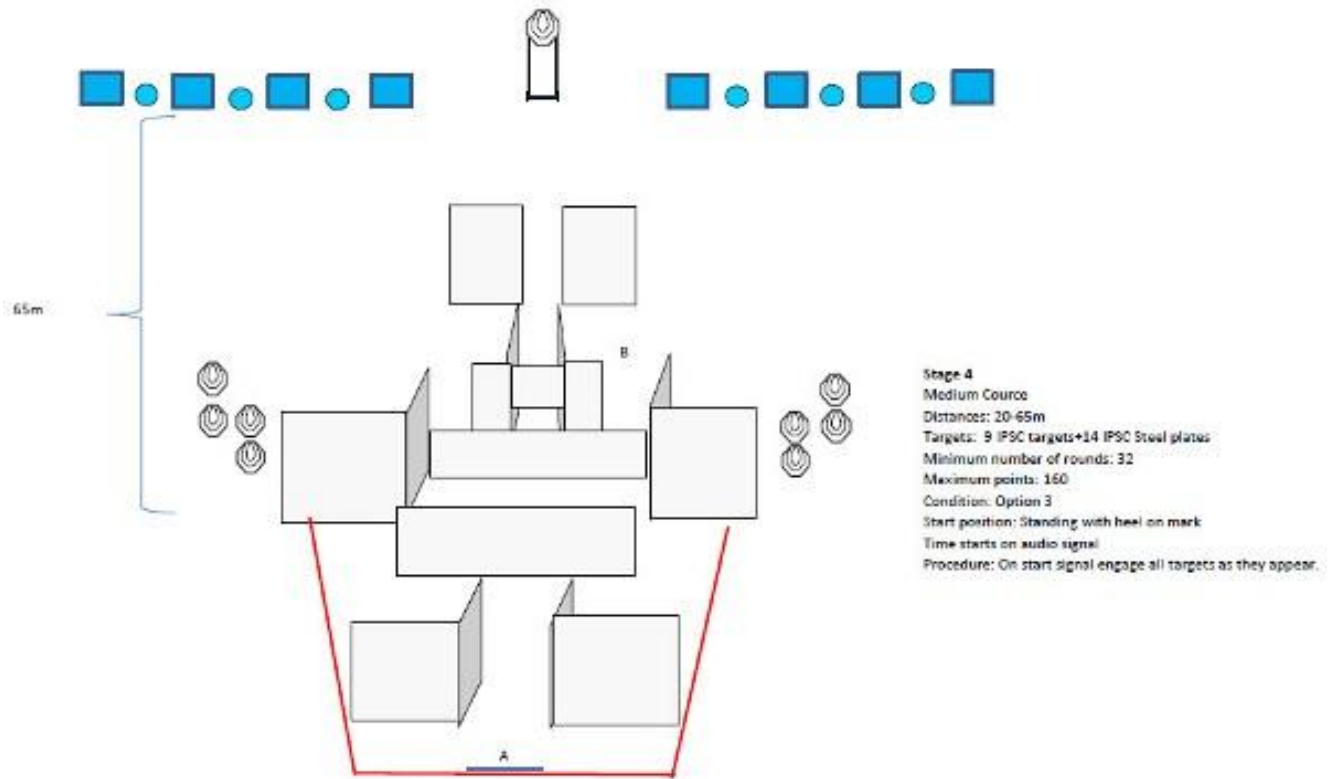

CoF	Comstock - Long	Points	160 p
Targets	9 paper, 14 plates, Total 23 targets	Min rounds	32
Firearm	Rifle	Match-%	20.13%

Procedure	On start signal engage all targets as they appear. Standing with heel on mark.
Starting position	Option 3
Firearm ready condition	
Start on	Audible signal
Stop on	Last shot
Penalties	As per current edition of rules
Safety angles	L/R
Setup notes	

5. Stage 5

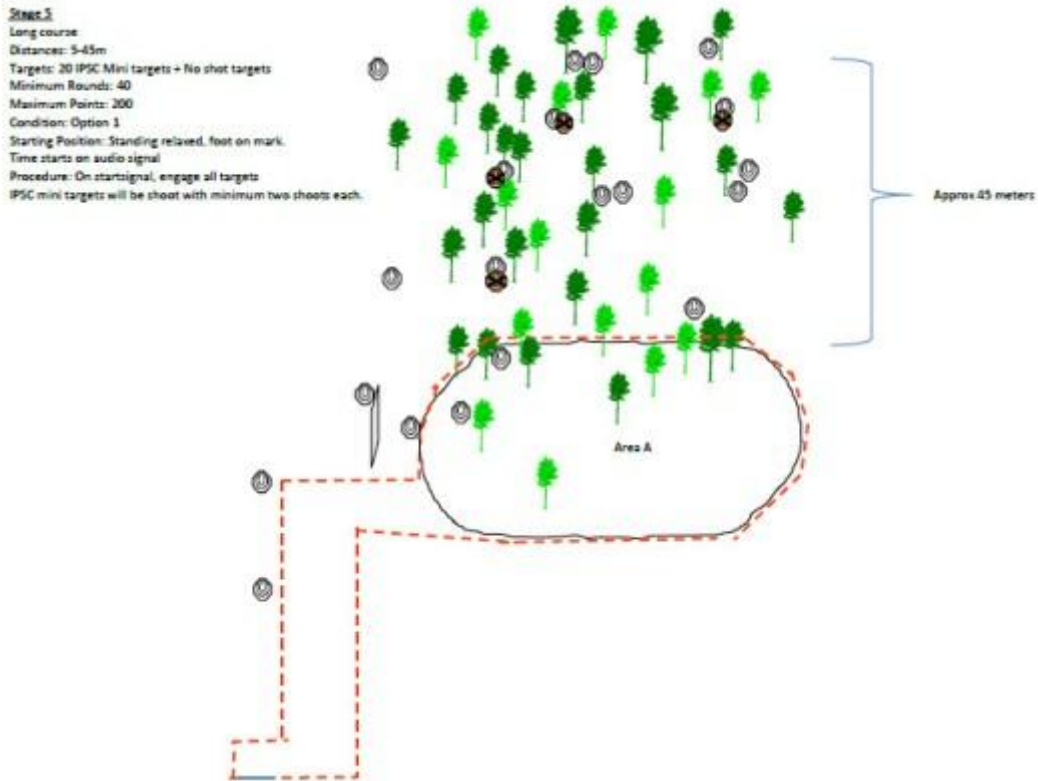

CoF	Comstock - Long	Points	200 p
Targets	20 paper, Total 20 targets	Min rounds	40
Firearm	Rifle	Match-%	25.16%

Procedure	On startsignal, engage all targets, IPSC mini targets will be shoot with minimum two shoots each.
Starting position	Option 1
Firearm ready condition	
Start on	Audible signal
Stop on	Last shot
Penalties	As per current edition of rules
Safety angles	L/R
Setup notes	

6. Stage 6



STAGE: 6

Medium Course

Distances: 40-160m

Targets: 8 IPSC Targets +

1 IPSC Steel plate (self indicating)+1 IPSC popper

Minimum Rounds: 18

Maximum Points: 90

Condition: Option 3, gun in rifle stand

Start position: Sitting on chair

Time starts on audio signal

Procedure: On start signal engage all targets

IPSC targets will be shoot with minimum two shoots each.



CoF	Comstock - Medium	Points	90 p
Targets	8 paper, 1 popper, 1 plates, 2 no-shoot, Total 10 targets	Min rounds	18
Firearm	Rifle	Match-%	11.32%

Procedure	Sitting on chair with gun in rack. On start signal engage all targets, IPSC targets will be shoot with minimum two shoots each.
Starting position	Option 3
Firearm ready condition	
Start on	Audible signal
Stop on	Last shot
Penalties	As per current edition of rules
Safety angles	L/R
Setup notes	

7. Stage 7

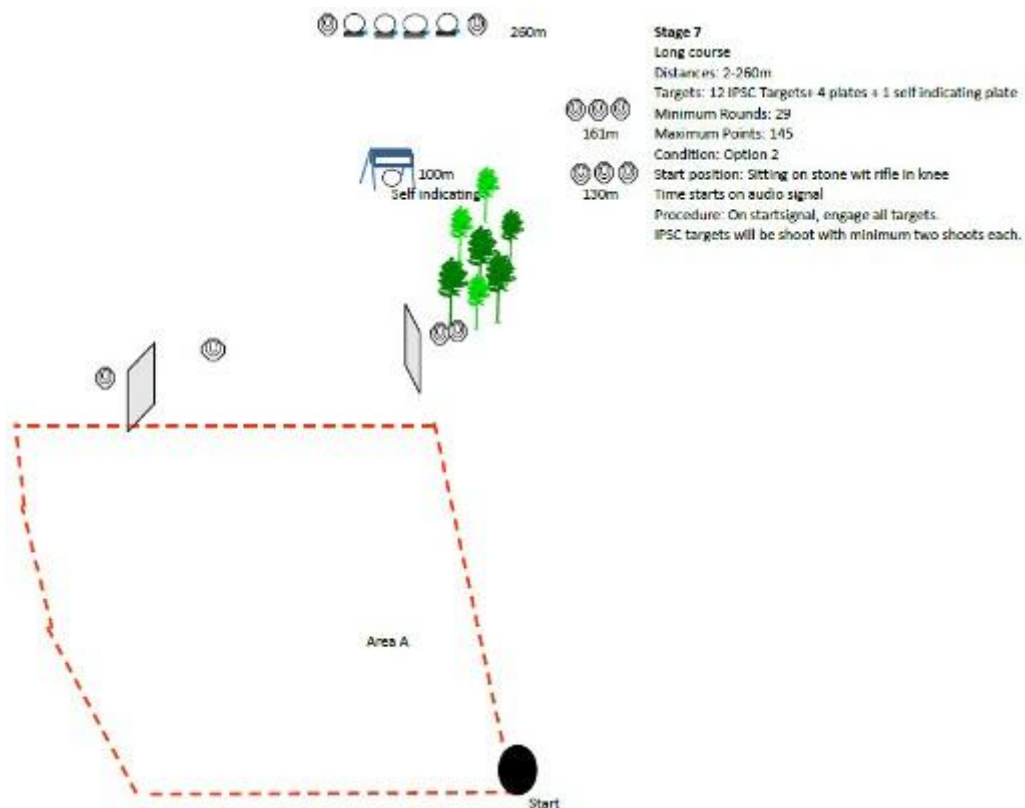

Stage 7
 Long course
 Distances: 2-260m
 Targets: 12 IPSC Targets: 4 plates + 1 self indicating plate
 Minimum Rounds: 29
 Maximum Points: 145
 Condition: Option 2
 Start position: Sitting on stone with rifle in knee
 Time starts on audio signal
 Procedure: On startsignal, engage all targets.
 IPSC targets will be shoot with minimum two shoots each.

CoF	Comstock - Medium	Points	95 p
Targets	7 paper, 5 plates, Total 12 targets	Min rounds	19
Firearm	Rifle	Match-%	11.95%

Procedure	Sitting on stone with rifle in knee. On startsignal, engage all targets. IPSC targets will be shoot with minimum two shoots each.
Starting position	Option 2
Firearm ready condition	
Start on	Audible signal
Stop on	Last shot
Penalties	As per current edition of rules
Safety angles	L/R
Setup notes	

8. Stage 8

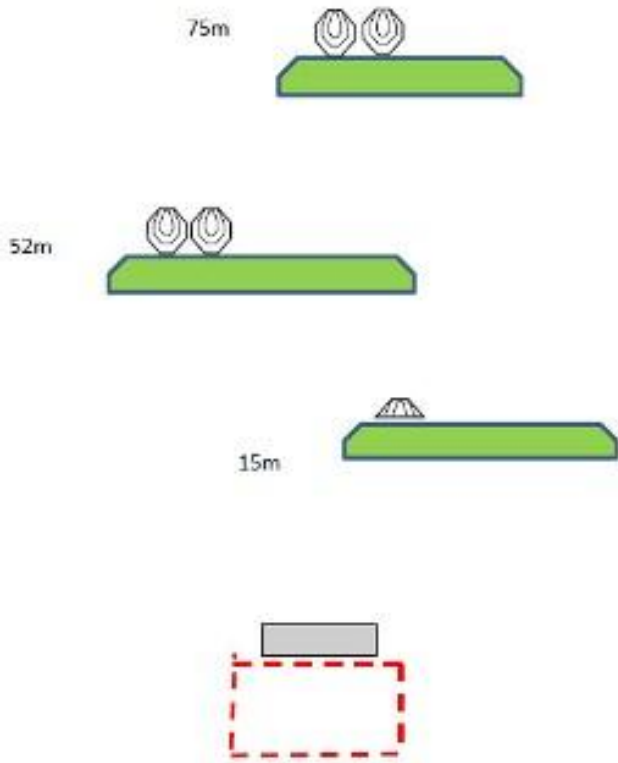

Stage 8

Short Course

Distances: 15-75m

Targets: 5 IPSC targets

Minimum Rounds: 10

Maximum Points: 50

Starting Position: Any where in Area A.

Condition: Option 1

Time starts on audio signal

Procedure: On startsignal, engage all targets with weak hand and gun on weak sholder

IPSC targets will be shoot with minimum two shoots each.

Hotrange with stage 1

CoF	Comstock - Short	Points	50 p
Targets	5 paper, Total 5 targets	Min rounds	10
Firearm	Rifle	Match-%	6.29%

Procedure	On startsignal, engage all targets with weak hand and gun on weak sholder from pallet. IPSC targets will be shoot with minimum two shoots each. Hotrange with stage 1.
Starting position	Option 1
Firearm ready condition	
Start on	Audible signal
Stop on	Last shot
Penalties	As per current edition of rules
Safety angles	L/R
Setup notes	