

# 1. Klubbstugan

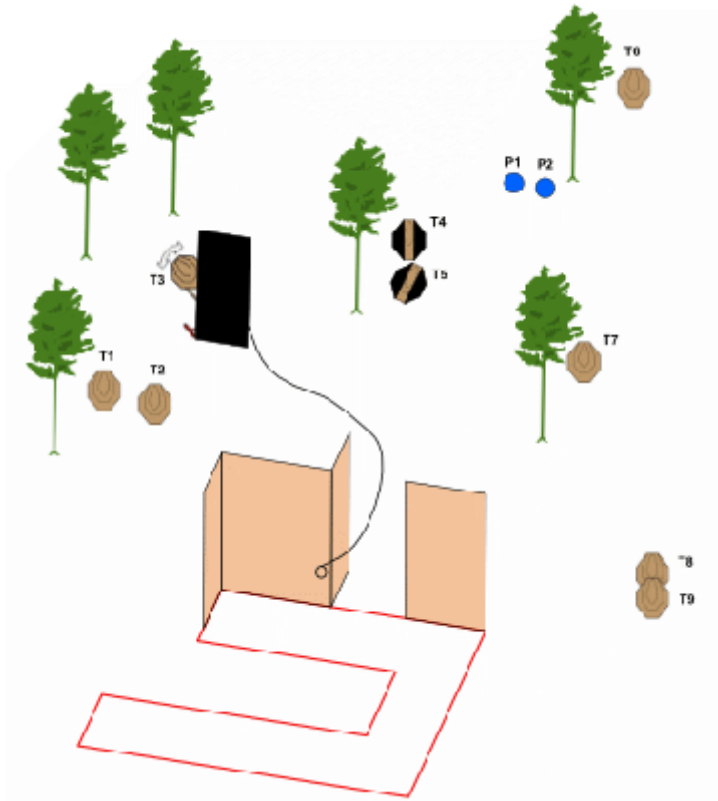

CoF	Comstock - Medium	Points	100 p
Targets	9 paper, 2 plates, Total 11 targets	Min rounds	20
Firearm	Mini Rifle	Match-%	9.66%

Procedure	On signal engage all targets, pulling the rope activate swinger T3, that are visible at rest.
Starting position	Anywhere inside the designated area
Firearm ready condition	Option 1
Start on	Audible signal
Stop on	Last shot
Penalties	As per current edition of rules
Safety angles	Red stick with flag on left and right
Setup notes	Distances: 10-80 meter.

## 2. Morgans glänta

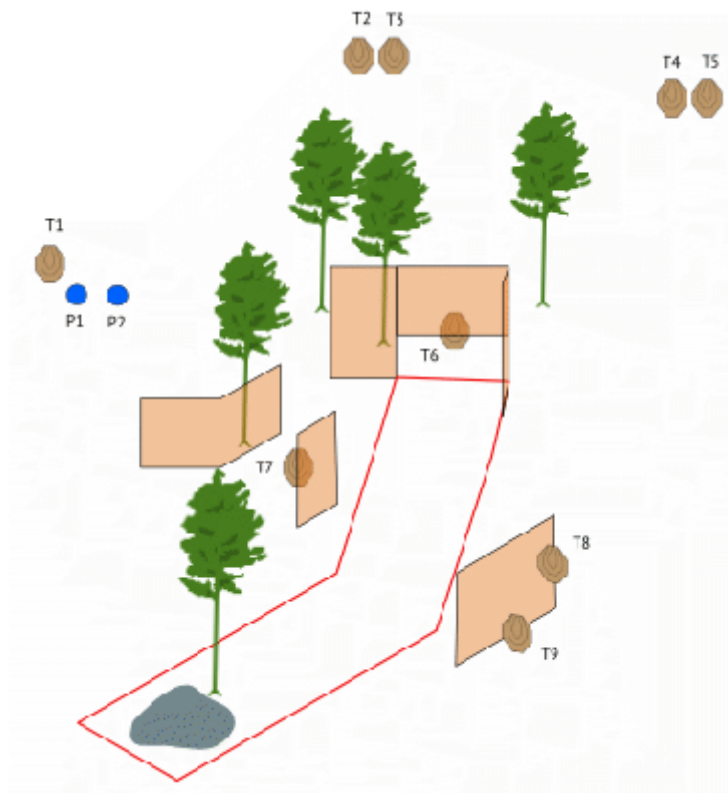

CoF	Comstock - Medium	Points	100 p
Targets	9 paper, 2 plates, Total 11 targets	Min rounds	20
Firearm	Mini Rifle	Match-%	9.66%

Procedure	On signal engage all targets.
Starting position	Sitting on rock as demonstrated.
Firearm ready condition	Option 1
Start on	Audible signal
Stop on	Last shot
Penalties	As per current edition of rules
Safety angles	Red stick with flag on left and right
Setup notes	Distances: 3-40 meter.

### 3. Vänster pistolbana

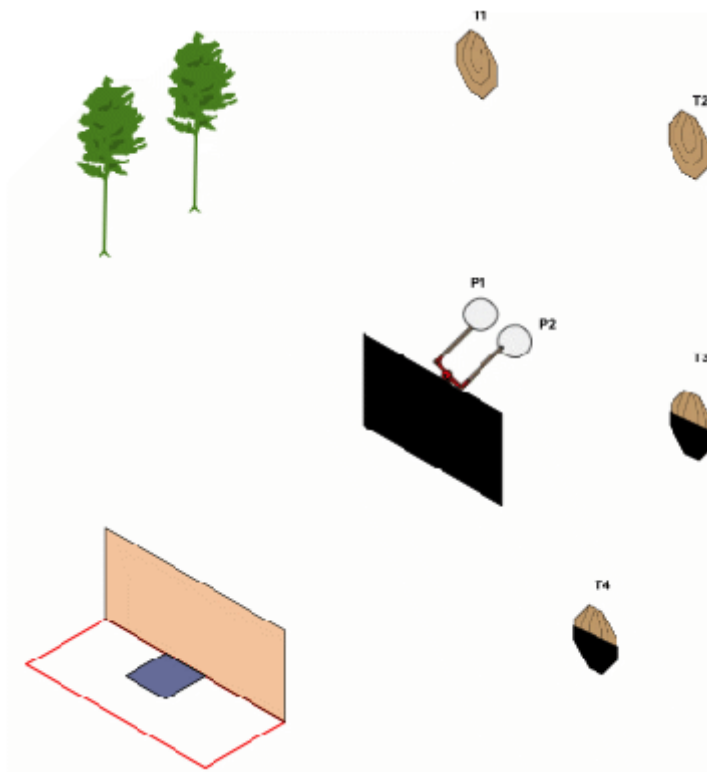

CoF	Comstock - Short	Points	50 p
Targets	4 paper, 2 plates, Total 6 targets	Min rounds	10
Firearm	Mini Rifle	Match-%	4.83%

Procedure	On signal engage all targets, press plate to activate swingerplates (P1 and P2), that are visible at rest.
Starting position	Anywhere inside designated area.
Firearm ready condition	Option 1
Start on	Audible signal
Stop on	Last shot
Penalties	As per current edition of rules
Safety angles	Red stick with flag on left and right
Setup notes	Distances: 7-20 meter

## 4. Pistolvallen

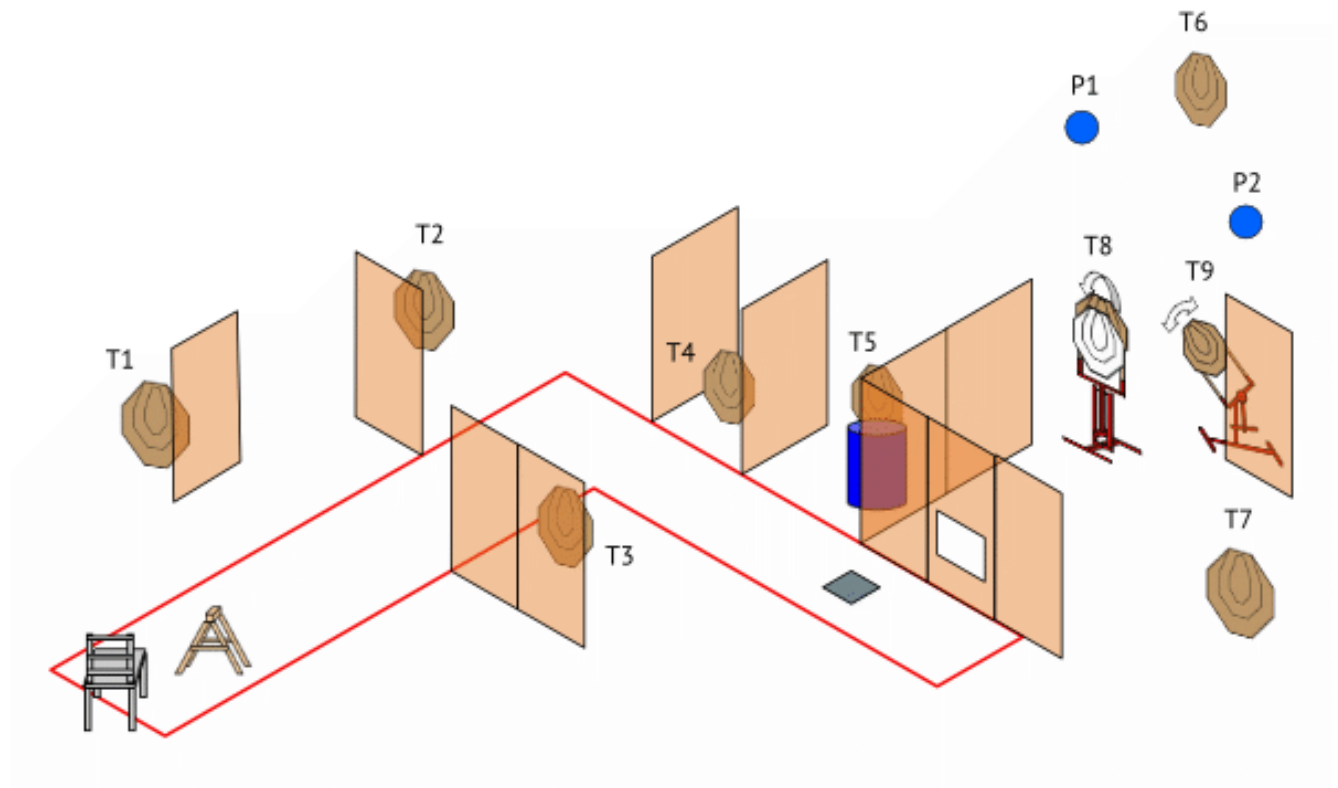

CoF	Comstock - Medium	Points	100 p
Targets	9 paper, 2 plates, Total 11 targets	Min rounds	20
Firearm	Mini Rifle	Match-%	9.66%

Procedure	On signal engage all targets. Pressing plate release moving targets T8 and T9 that are visible at rest
Starting position	Sitting on chair, heels touching legs of chair.
Firearm ready condition	Rifle in gun rack. Option 2
Start on	Audible signal
Stop on	Last shot
Penalties	As per current edition of rules
Safety angles	Red stick with flag on left and right
Setup notes	Distances: 3-12 Meter.

# 5. Gevärsvallen

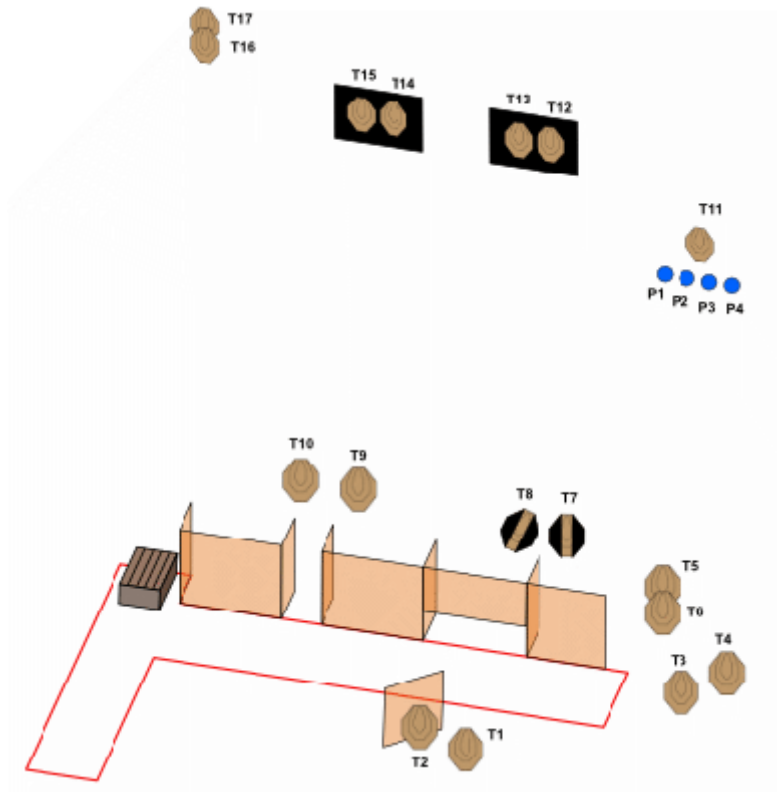

CoF	Comstock - Long	Points	190 p
Targets	17 paper, 4 plates, Total 21 targets	Min rounds	38
Firearm	Mini Rifle	Match-%	18.36%

Procedure	On signal engage all targets.
Starting position	Anywhere inside the designated area.
Firearm ready condition	Option 1
Start on	Audible signal
Stop on	Last shot
Penalties	As per current edition of rules
Safety angles	Red stick with flag on left and right.
Setup notes	Distances: 5-110 Meter.

## 6. Dansbanan

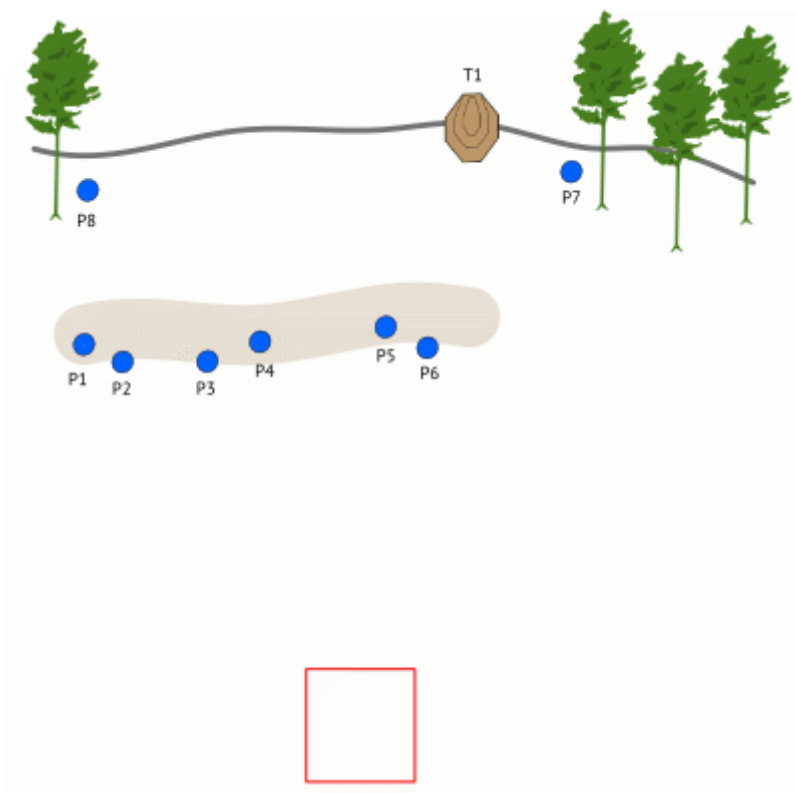

CoF	Comstock - Short	Points	50 p
Targets	1 paper, 8 plates, Total 9 targets	Min rounds	10
Firearm	Mini Rifle	Match-%	4.83%

Procedure	On signal engage all targets.
Starting position	Anywhere inside the designated area.
Firearm ready condition	Option 1
Start on	Audible signal
Stop on	Last shot
Penalties	As per current edition of rules
Safety angles	Red stick with flag on left and right.
Setup notes	Distances: 15 -23 meter.

# 7. Höger skeet

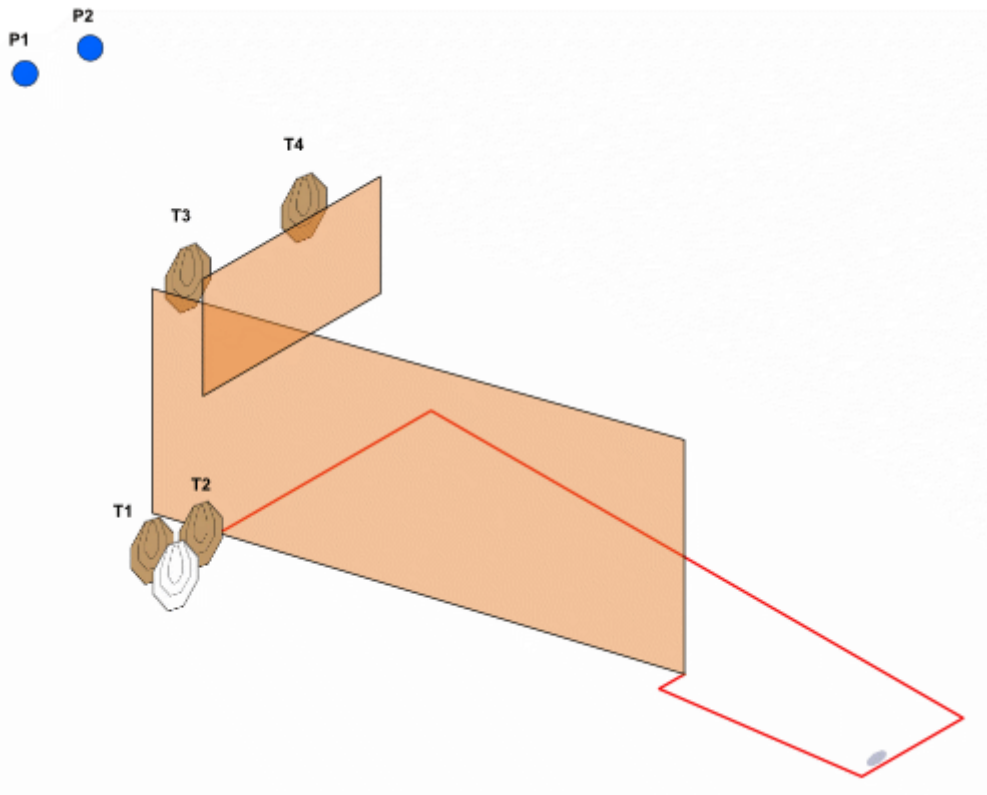

CoF	Comstock - Short	Points	50 p
Targets	4 paper, 2 plates, Total 6 targets	Min rounds	10
Firearm	Mini Rifle	Match-%	4.83%

Procedure	On signal engage all targets.
Starting position	Heels on mark.
Firearm ready condition	Option 1
Start on	Audible signal
Stop on	Last shot
Penalties	As per current edition of rules
Safety angles	Red stick with flag on left and right.
Setup notes	Distances: 15-40 meter.

## 8. Vänster skeet

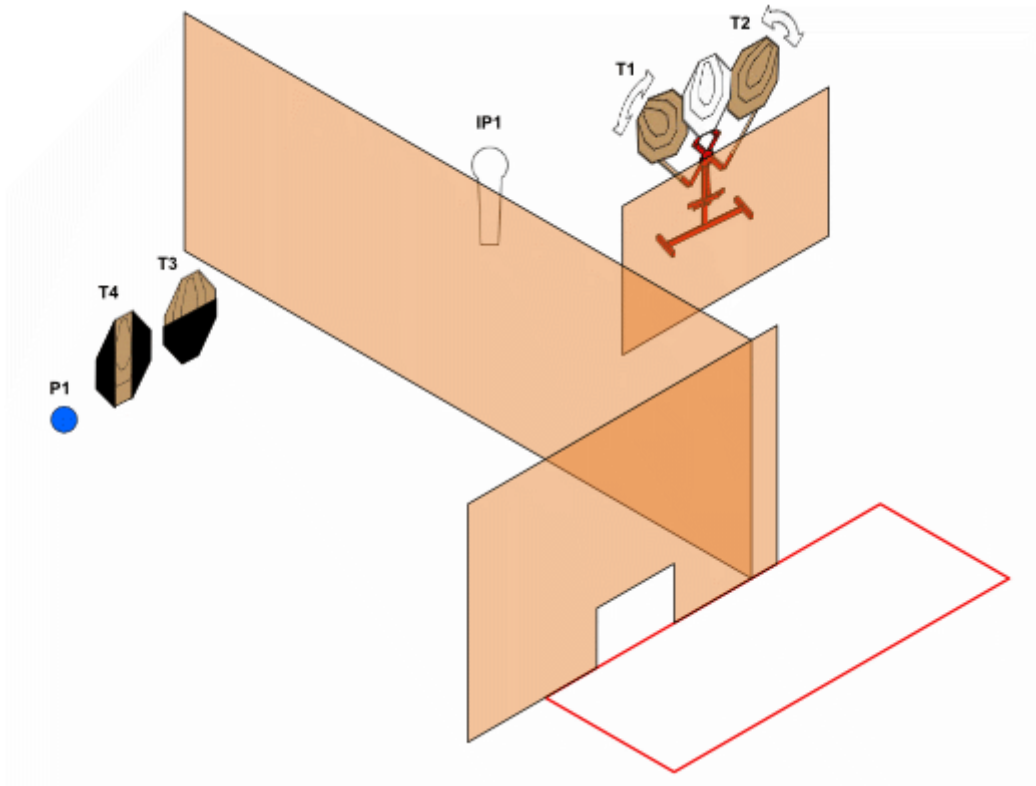

CoF	Comstock - Short	Points	50 p
Targets	4 paper, 1 popper, 1 plates, Total 6 targets	Min rounds	10
Firearm	Mini Rifle	Match-%	4.83%

Procedure	On signal engage all targets. IP1 activates T1 and T2 and are visible at rest
Starting position	Anywhere inside designated area
Firearm ready condition	Option 1
Start on	Audible signal
Stop on	Last shot
Penalties	As per current edition of rules
Safety angles	Red stick with flag on left and right
Setup notes	Distances: 10-25 meter.



# 9. Ravinen

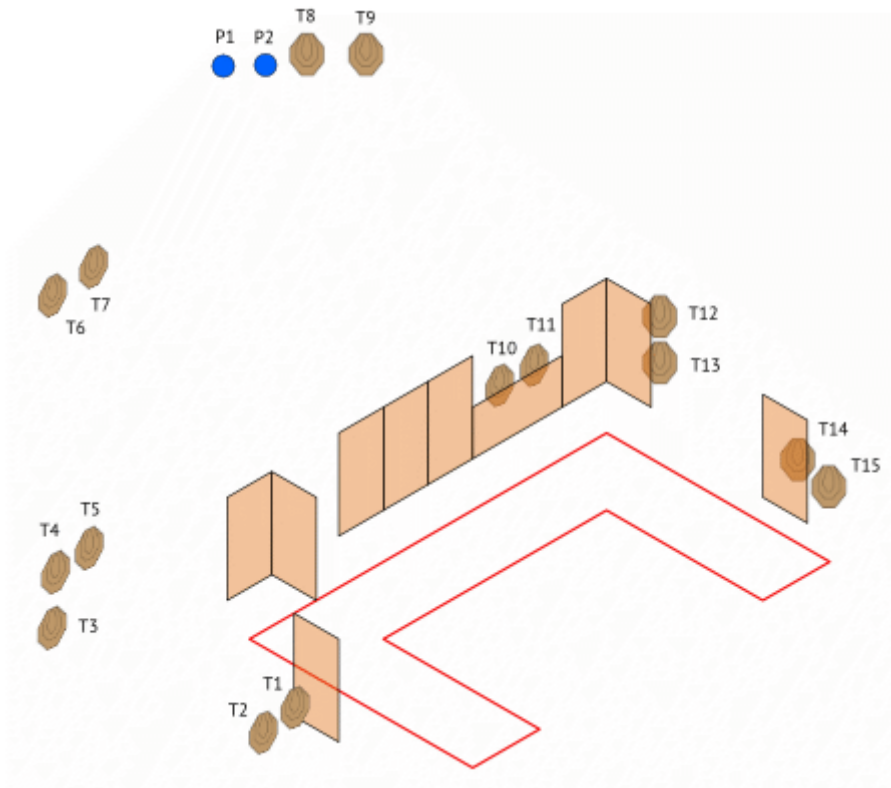

CoF	Comstock - Long	Points	160 p
Targets	15 paper, 2 plates, Total 17 targets	Min rounds	32
Firearm	Mini Rifle	Match-%	15.46%

Procedure	On signal engage all targets
Starting position	Anywhere inside the designated area
Firearm ready condition	Option 1
Start on	Audible signal
Stop on	Last shot
Penalties	As per current edition of rules
Safety angles	Red stick with flag on left and right
Setup notes	Distances 8-70 meter.

# 10. Älgbanan

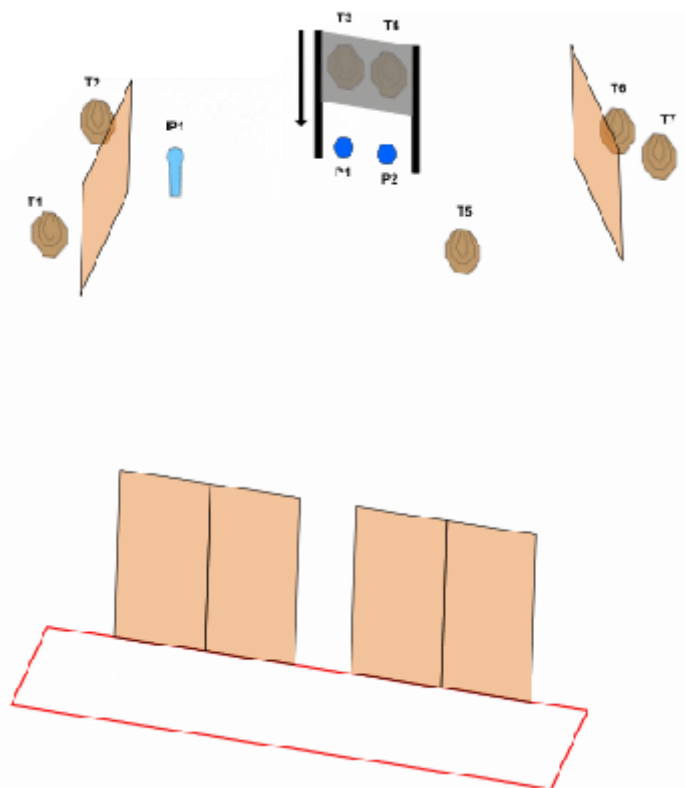

CoF	Comstock - Medium	Points	85 p
Targets	7 paper, 1 popper, 2 plates, Total 10 targets	Min rounds	17
Firearm	Mini Rifle	Match-%	8.21%

Procedure	On signal engage all targets. IP1 will activate hatch 1 that will make T3-T4 visible. All targets and plates will be visible before or after startsignal.
Starting position	Anywhere inside the designated area
Firearm ready condition	Option 1
Start on	Audible signal
Stop on	Last shot
Penalties	As per current edition of rules
Safety angles	Red stick with flag on left and right
Setup notes	Distances: 35-40 meter.

# 11. Småviltbanan

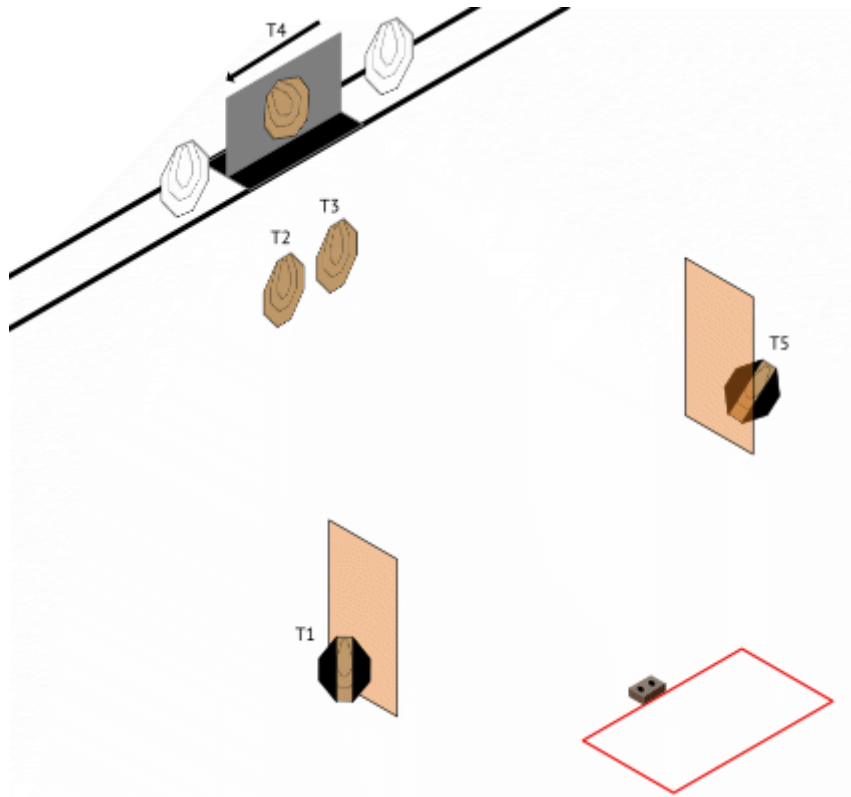

CoF	Comstock - Short	Points	50 p
Targets	5 paper, Total 5 targets	Min rounds	10
Firearm	Mini Rifle	Match-%	4.83%

Procedure	On signal engage all targets. Pushing the button activates mover T4, and can be restarted.
Starting position	Anywhere inside the designated area.
Firearm ready condition	Option 1
Start on	Audible signal
Stop on	Last shot
Penalties	As per current edition of rules
Safety angles	Red stick with flag on left and right
Setup notes	Distances: 10-30 meter.

## 12. Olympic trap

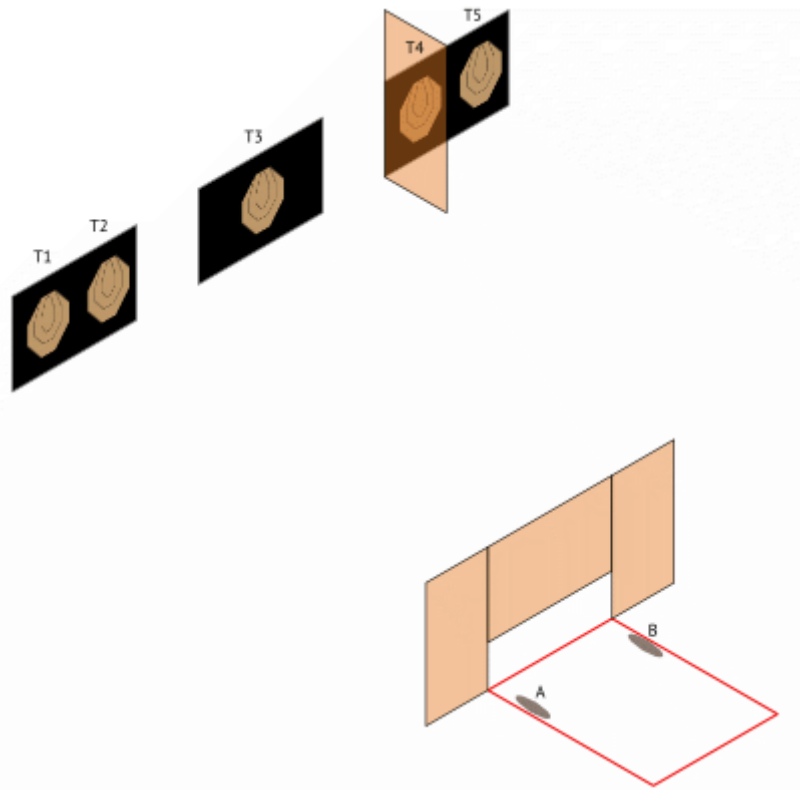

CoF	Comstock - Short	Points	50 p
Targets	5 paper, Total 5 targets	Min rounds	10
Firearm	Mini Rifle	Match-%	4.83%

Procedure	On signal engage all targets.
Starting position	Laying on stomach, hands under chin, inside area.
Firearm ready condition	Rifle laying flat on ground at mark A or B. Option 1
Start on	Audible signal
Stop on	Last shot
Penalties	As per current edition of rules
Safety angles	L/R
Setup notes	Distances: 25 meter.